

INSTRUCTIONS PERTAINING TO;
RISK OF FIRE, ELECTRIC SHOCK OR
HARM TO PERSONS

IMPORTANT SAFETY INSTRUCTIONS

WARNING - When using electric appliances, basic precautions should always be followed, including the following:

- 1) Read all the instructions before using appliance.
- 2) To reduce the risk of injury, close supervision is necessary when an appliance is used near children.
- 3) Only use attachments recommended or sold by the manufacturer.
- 4) Do not use outdoors. FOR INDOOR USE ONLY.
- 5) Do not unplug by pulling on the cord. To unplug, grasp the plug, not the cord.
- 6) Do not operate any appliance with a damaged cord or plug, or after the appliance malfunctions or is dropped or damaged in any manner. Return appliance to the nearest authorized service facility for examination, repair, or electrical or mechanical adjustment.
- 7) For a portable appliance - To reduce the risk of electrical shock, do not place or store appliance where it can fall or be pulled into a tub or sink.
- 8) Always unplug any appliance when not in use, before putting on or taking off parts, and before cleaning. Never yank a cord to remove from the outlet.

SAVE THESE INSTRUCTIONS

DRINKWELL®

THE ORIGINAL PET FOUNTAIN®

U.S. Patents No. 5,799,609 and 5,842,437

IMPORTANT!

Keep these instructions for information about:

- cleaning and maintenance to keep your fountain working properly
- warranty coverage

FOR HOUSEHOLD USE ONLY

OPERATING INSTRUCTIONS

DO NOT RUN DRY

PET FOUNTAIN:

1. Inspect the bottom of the fountain to be sure the motor is securely attached (Fig. 1).

2. Remove the housing cover (lid) and insert the filter cartridge down into the well in the housing. It fits in the well diagonally (Figs. 2 A and B). The bottom of the filter is narrower than the top and the black side faces outward (toward the spout). If the fit is too tight, it is either in upside down or in the wrong groove at the front (Move it back one groove). RINSING the filter before use will help remove any loose bits of charcoal, which are harmless.

3. Fill the fountain with water, (both the bowl and the housing where the filter sits). See step 6.

4. Place in desired location. If placing on carpet or wood floor, the use of a protective surface is recommended for under the fountain.

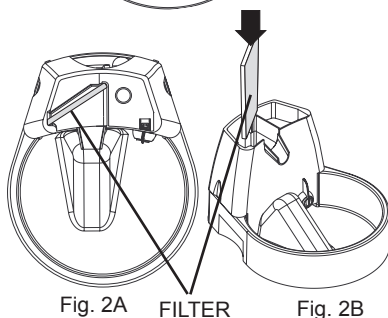
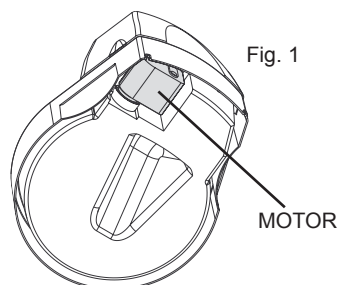

5. Make certain the cord and plug are dry, then plug into a polarized outlet. (One slot is larger than the other). The plug will only fit into a polarized outlet. Do not attempt to force it into an old, unsafe outlet. Use an adapter if necessary.

- There are notches for the power cord on both sides of the bottom of the fountain.

The notches are a pass-through for the cord. They are not for holding the cord snugly, which might damage the cord. The cord should be passed through vertically. DO NOT turn the cord horizontally and FORCE into a notch as this may damage the cord and create a hazard.

6. Add more water to the bowl after the unit is primed and running. For quietest operation, fill bowl completely. **A gentle hum during normal operation is to be expected.**
7. Set the desired flow rate with the flow control knob, which is next to the ramp in the bowl (minimum rate at 11 o'clock position, maximum rate at 1 o'clock position).
8. Add water to the bowl as needed. (The bowl holds 50 oz. of water). During regular use, do not allow the water level to fall below the inlet grate on the bottom of the flow control knob, or the motor may run dry.

CLEANING AND MAINTENANCE INSTRUCTIONS

The Fountain Must Be Cleaned To Continue Working Normally!

FILTERS:

1. Filters should be changed approximately every six to eight weeks. Replace filters more frequently when using the fountain for dogs. **FOR REPLACEMENT FILTERS, VISIT A PET STORE NEAR YOU OR CALL 866-322-2530.**
2. Filters may be rinsed out when the fountain is cleaned. Do not wash with soapy water since you cannot remove all the soap residue.
3. Filters are an added feature of the fountain. Their use is not required for normal operation.

FOUNTAIN:

Lack of cleaning may result in loss of normal function! Clean fountain and the internal cavity of the motor with soapy water about every two weeks. In between, (weekly) take apart and rinse with hot water.

1. Unplug the fountain, remove the cover and pull out the filter.

2. Empty the water out of the fountain.

3. Remove the filter housing by pressing in the tabs at the sides (Fig. 3) and lifting up.

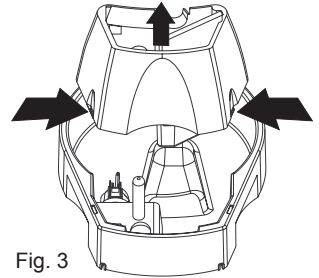

Fig. 3

4. The flow control knob and stator are not attached and are freed when the housing is removed.

5. **IMPORTANT - The motor must be cleaned regularly or the warranty may be voided!**

a. Turn the bowl over and remove the motor from its cavity by slipping your finger into the indentation behind the motor (Fig. 4A) and pulling that end of the motor out toward you so that it has turned a quarter of a turn, (Fig. 4B). Do not attempt to remove motor without turning it 90 degrees, this may damage the fountain and cause a leak.

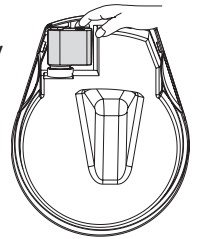

Fig. 4A

b. Now that the motor is unlocked it may be pulled out. If you find that difficult, you can push it out from the bowl side. (NOTE: To make removal easier, place a light coat of petroleum jelly around the rubber O ring before reinstalling).

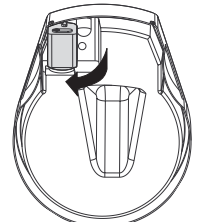

Fig. 4B

c. Carefully lift the impeller (the white "propeller") out of the motor. It should slide out easily with no resistance. Remove any hair tangled around it and wash it with the rest of the parts.

d. Pour soapy water down inside the cavity in the motor and clean out with a small round bristle brush (obtained wherever aquarium supplies are sold). Rinse well and replace the impeller after it is cleaned.

6. Hand wash the rest of the fountain parts in soapy water and rinse well. (If your dishwasher runs too hot the plastic may be damaged so hand washing is preferred). Use a bottle brush or aquarium brush to clean the square discharge tube in the filter housing, (Fig. 5).

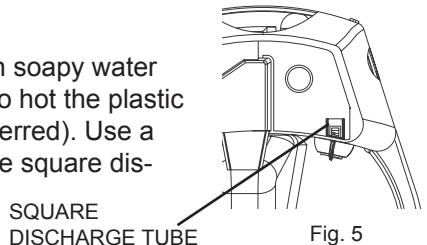
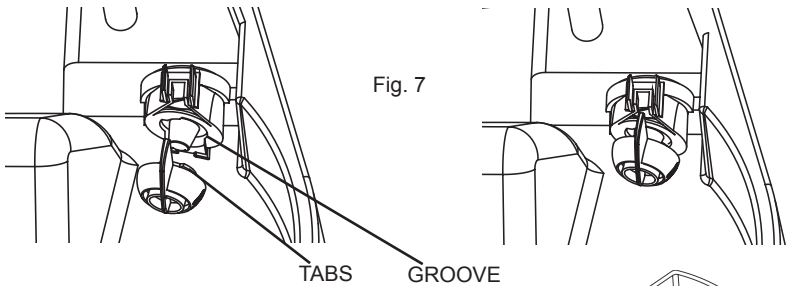
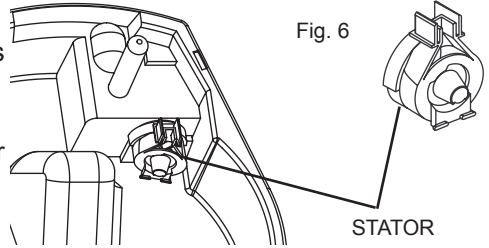

Fig. 5

REASSEMBLY OF YOUR FOUNTAIN AFTER CLEANING

1. Turn the bowl over. Reattach the motor by pushing the threads of the motor through its hole in the bowl. The motor goes in at a right angle to the bowl, (as it was when you pulled it out toward you to remove it, Fig. 4B). In order for the motor to screw or turn into place, the threads must be pushed past the threads of the bowl. If you cannot turn the motor into its resting position, it is not pushed into the hole as far as it will go.
2. Turn the motor into its resting position by pushing the end that is jutting out towards the bowl. The motor should now be even with the bottom of the bowl.
3. Place the stator over the neck of the motor (Fig. 6). Make certain it is straight, (in the 12 o'clock position).
4. Join the flow control knob and stator together by placing the tabs of the knob into the groove of the stator, (Fig. 7).



5. HOLD THESE PARTS IN PLACE with one hand while attaching the housing with the other hand, (Fig. 8). Attach the housing by just sliding the cutout in the wall of the housing down IN BETWEEN the control knob and the stator, (Fig 9).

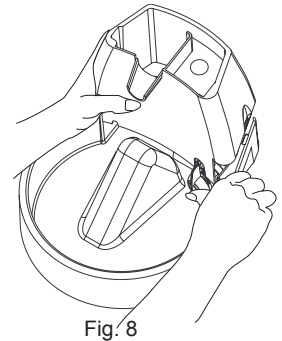

The housing will click into place when the tabs on its sides enter the slots in the bowl. There is an alignment peg in the bowl for stability which will automatically be joined with the corresponding hollow tube under the housing.

6. CHECK THE POWER CORD FOR ANY DAMAGE BEFORE PLUGGING IN THE FOUNTAIN.

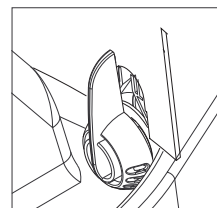

THE FOUNTAIN AND YOUR ENVIRONMENT

If you live in a humid environment and have problems with mold or algae, (the parts may feel “slimy”), simply soak all of the parts in a diluted bleach solution for about 10 minutes after regular cleaning. (Use one or two cups of bleach in a sink full of water). Pour some of the bleach solution down into the motor cavity, too. This is also an excellent way to disinfect the fountain. You must be sure to rinse all the parts very well to remove all the chlorine. The best way to rinse out the motor cavity is to hold it under a weak stream of water.

If you have “hard water” you may start to see white mineral deposits on or down inside the motor. This may eventually prevent the impeller from turning properly. To avoid having to replace the motor:

- a. Clean the motor more frequently than you have in the past; or
- b. Clean with a vinegar solution and let the solution soak for several minutes down inside the cavity; or
- c. Use bottled water.

TIPS ON USE

When being introduced to the Drinkwell Pet Fountain, your pet may have the good sense to be cautious of this new and unusual object. After beginning operation of your Fountain, simply allow your pet to adjust at his or her own pace. Some pets take several days or longer to begin use.

Your pet may prefer that the Fountain be placed away from their normal feeding area. Try plugging it in somewhere else, like the laundry room, a bathroom or another corner of the kitchen. For cats, another idea is to place it up on a counter in an acceptable area.

Add ice cubes to the bowl for refreshing, ice-cold running water!

MANUFACTURER'S SAFETY INSTRUCTIONS

1. While the capacity of the next generation Fountain has been increased, it is not recommended that any appliance be left running unattended for a prolonged period of time.
2. Do not allow pets or children to chew on or swallow any parts. If you are concerned about the power cord, purchase a cord conduit (a hard plastic protector) at any hardware store.

3. Standard Safety Precautions

Do not attempt repairs on the motor yourself. Return it under the cover of the warranty.

If the plug of this device gets wet, turn off the electricity to that outlet. Do not attempt to unplug.

To avoid the possibility of the plug or outlet getting wet, the outlet should always be above the level of the Fountain.

Examine this appliance after installation. It should not be plugged in if there is water on the cord or plug.

Do not operate any appliance if it has a damaged cord or plug, or if it is malfunctioning or has been damaged.

If an extension cord is necessary, a cord with a proper rating should be used.

The electrical use of this appliance is 6 watts.

4. Some cats have been known to be sensitive to plastic food and water containers. If your cat shows signs of an allergic reaction to the plastic, please discontinue use until you have consulted with your veterinarian.

Close supervision is necessary when any appliance is used by or near children.

Always unplug any appliance when not in use, before putting on or taking off parts, and before cleaning. Never yank a cord to remove from the outlet.

Do not use appliance for other than intended use. The use of attachments not recommended or sold by the manufacturer may cause an unsafe condition. Do not modify the unit.

Do not install or store appliance where it will be exposed to weather or temperatures below freezing.

FOR HOUSEHOLD/ INDOOR USE ONLY.

Read and observe all important notices on the appliance.

WARRANTY

Motor, Fountain Parts and/or Additional Capacity Reservoir

The motor assembly and fountain parts and/or additional capacity reservoir parts are warranted to be free of defects in material and workmanship for one (1) year from the date of purchase. If defective, return DEFECTIVE PARTS ONLY with proof of purchase plus \$3.00 shipping and handling to:

Veterinary Ventures, Inc.
P.O. Box 19717
Reno, NV 89511

This warranty does not cover damage from accident, misuse or abuse. It also specifically excludes incidental or consequential damages as allowed by law. LOSS OF FUNCTION AS A RESULT OF LACK OF CLEANING, DEBRIS OR MINERALIZATION FROM "HARD" WATER DOES NOT QUALIFY under this warranty. (Refer to cleaning instructions and environmental notes)

